

**FIRSTIME & CO.**<sup>®</sup>  
— AMERICAN DESIGNED —





# INSTRUCTION MANUAL

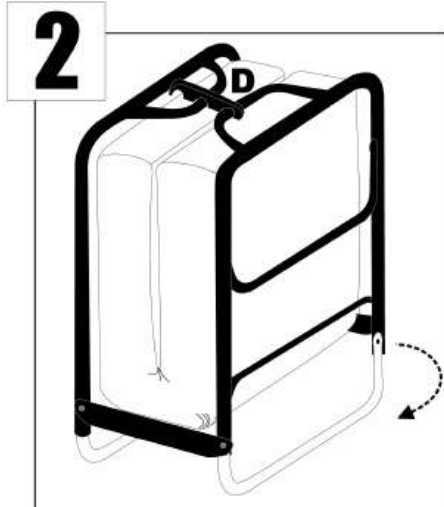
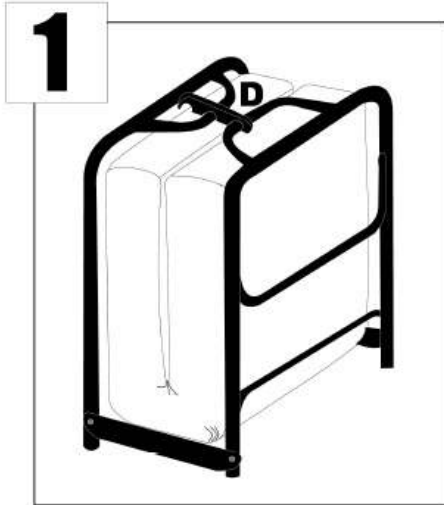

**F-Torino Folding Bed**

# F-TORINO FOLDING BED



Contents		
<b>A</b>		<b>x 4</b>
<b>B</b>		<b>x 4</b>
<b>C</b>		<b>x 4</b>
<b>D</b>		<b>x 1</b>
	1 2 3 Do not use	
<b>E</b>		<b>x 2</b>

## ASSEMBLY INSTRUCTIONS

- Carefully remove plastic wrap and cardboard packing and cut plastic band.
- Open bed and remove parts for assembly.
- Close bed and snap Part D (clip-lock bar) into place, using slots (1) and (2) as shown in illustration. Do not use slot (3).
- Sit closed bed upright (figure 1).
- Open two center legs (figure 2).
- To secure the legs, you will use both Part E (leg cross-bars) to connect the center legs together (figure 3).
  - Use Part E (leg cross-bar) to connect the legs. Placing the flat side of each cross-bar against the bottom of the two legs, align them with the holes, insert Part A (caster) into hole and secure with Part B (nut). Repeat with remaining casters and nuts.
- Stand bed upright and insert the four Part C (plastic leg caps) by inserting the center tabs into the holes on the outside legs (figure 4).

## TO USE BED:

- Unfold legs by pulling each leg upward until it is perpendicular to side of folded bed.
  - Release Part D (clip-lock bar) on top of folded bed by grasping finger hole at one end and pulling upward. When clip-lock bar releases, lower one side of the bed until leg rests on floor. Then, lower opposite side of bed until leg rests on floor and bed is fully open.
- NOTE: AS CLIP-LOCK IS RELEASED, HOLD HANDLES ON TOP OF BED TO PREVENT BED FROM OPENING TOO RAPIDLY.**
- After use, fold bed and secure with clip-lock bar for easy storage.

