

81004 ASSEMBLY INSTRUCTIONS

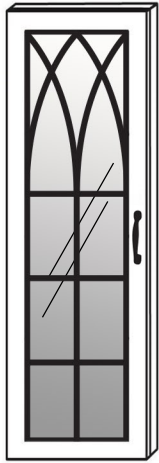

A 1 PC

Double sided tape

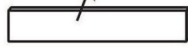

B 1 PC



C 3 PCS



D 6 PCS



E 6 PCS

Over The Door

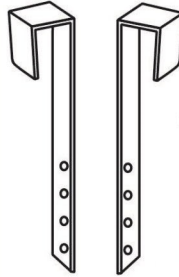

F
2 PCS



H
1 PC



G 4 PCS



I
2 PCS



J
4 PCS

Wall Mount

Anchor 2 set

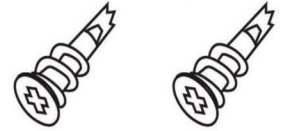

K 2 PCS



L 2 PCS

Over The Door

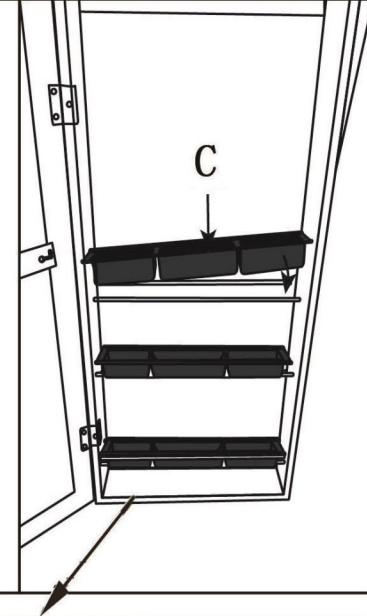
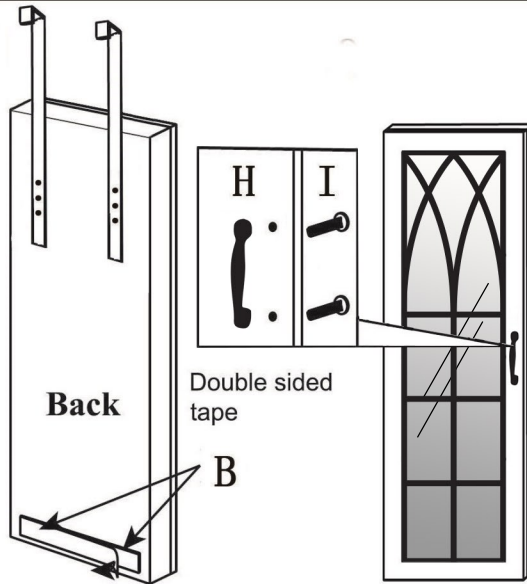
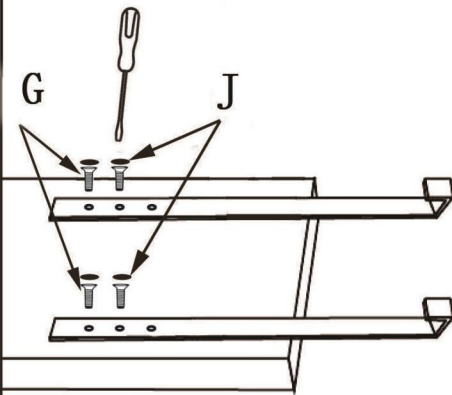

Wall Mount

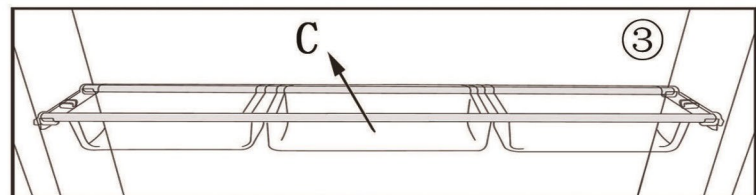
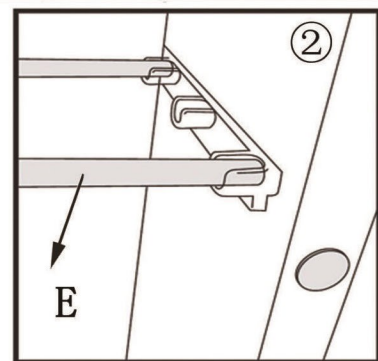
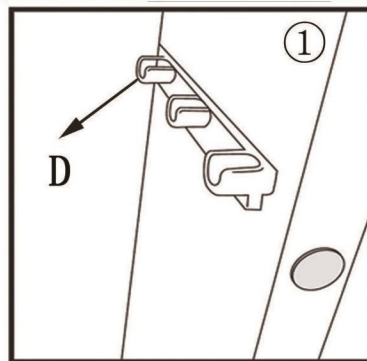
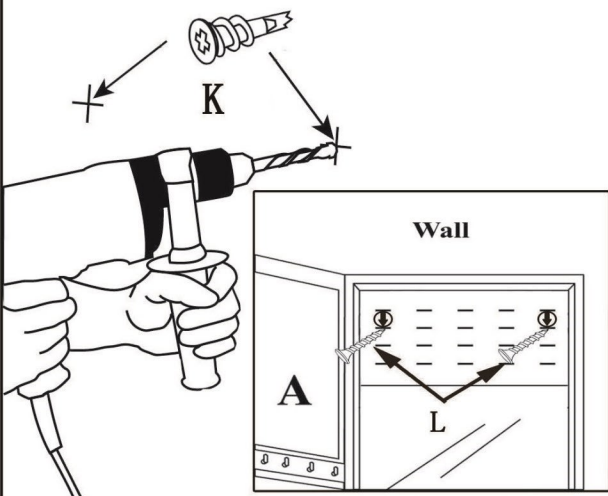

HANGING INSTRUCTIONS

Read these instructions carefully. Failure to follow these instructions can result in serious personal injury.

Over the door hanging instructions:

1. Determine your preferred height for hanging and position hooks to align with the corresponding hole
2. Before screwing the hooks onto the back of the cabinet make sure that the top of the hook is facing towards the door. (Fig A)
3. Screw in all 4 screws tightly to secure the hangers to the back of the cabinet
4. Place EVA foam dot on each of the 4 screw on the back of the cabinet
5. Hang the cabinet over your chosen door
6. Determine desired location for Velcro strips
7. Place one side of the Velcro strip to the back of the cabinet and the other side to the door to minimize movement of the cabinet on the door
8. Enjoy your new Cabinet!

Fig A. Hooks facing towards door

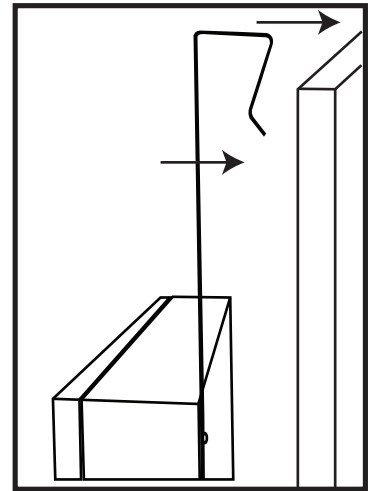

DOOR HANGING HARDWARE

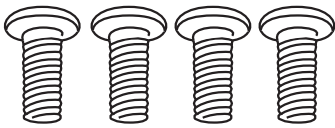

4 Screws for Door Hangers

Wall hanging instructions:

1. Place 1 EVA foam dot on each back corner of the cabinet
2. Determine your desired hanging location of the cabinet and mark where screws should go
3. Place wall anchors into the wall at marked spots; make sure anchors are level.

Drill hole at least 1/4" deeper than the anchor. (Requires 3/16 Drill bit)

Insert anchor until flange is flush with base material.

Fasten Screws through the back panel, from the interior of the cabinet and into the wall anchors in the wall.

4. Do not exceed 35 lbs in over all weight.
5. Enjoy your new Cabinet!

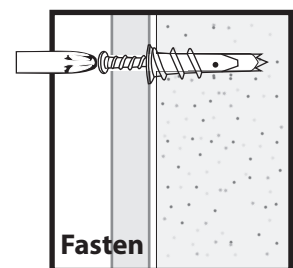
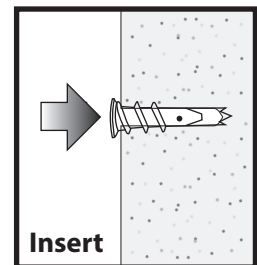
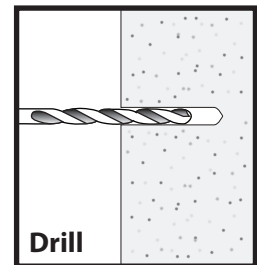

place screw through drill hole and tighten into anchor

WALL HARDWARE

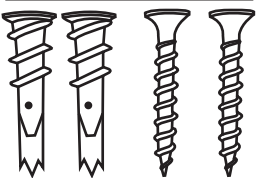

2 Wall Anchors & Screws

* Different wall materials may require a different type of fastener. Use fasteners suitable for the walls in your home.*
Designed for fastening in drywall and hollow block. Manufacturer shall not be liable for any fastening failure due to improper installation or defective substrate material.